

CLIPPATRICE AUTOMATICA MULTIPLA M.208/CN SU CONFEZIONATRICE VERTICALE MULTIPLE AUTOMATIC CLIPPING MACHINE M.208/CN FOR VERTICAL PACKAGING MACHINE

La principale innovazione che questa macchina presenta è la seguente:
Possibilità di utilizzare (a richiesta) clip di tre diverse misure di lunghezza (mm. 36/42/48) con una rapida operazione di cambio (5/10 minuti).

*The main innovation featuring this machine is listed here below:
Possibility of using (upon request) clips of three different sizes in length (mm. 36/42/48) a rapid change operation (5/10 minutes).*

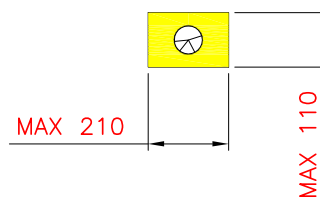
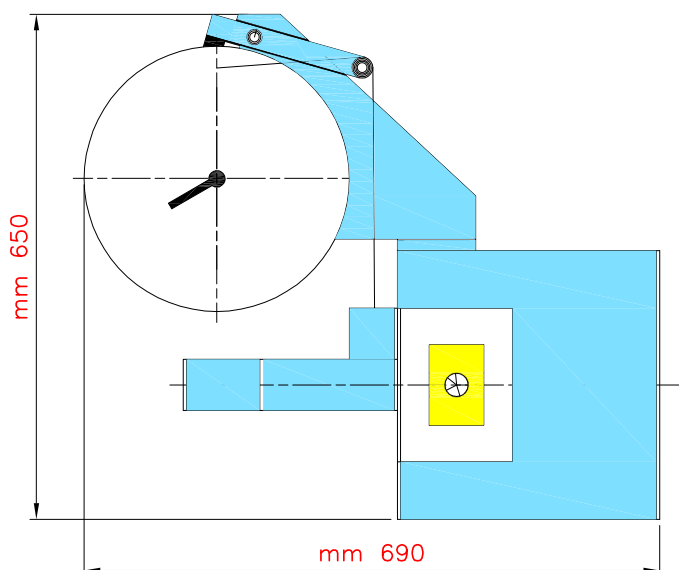
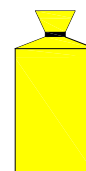
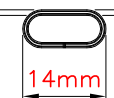
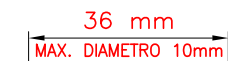
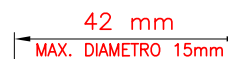
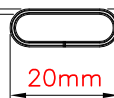
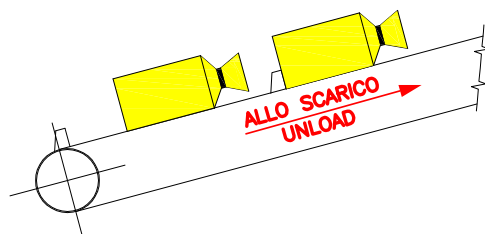
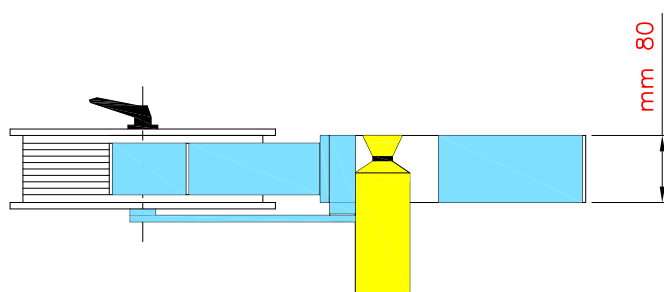

CLIPPATRICE AUTOMATICA MULTIPLA M.208/CN
SU CONFEZIONATRICE VERTICALE
MULTIPLE AUTOMATIC CLIPPING MACHINE M.208/CN
FOR VERTICAL PACKAGING MACHINE

Macchina automatica a clip band continuo plastificato con doppia anima in metallo, per la chiusura di ogni tipo di sacchetto. Compatta, semplice, sicura, è stata progettata con tecnologie di grande affidabilità. E' particolarmente indicata per il confezionamento di prodotti da forno, (pane, grissini, biscotti ecc.). Il caricamento dei sacchetti viene fatto direttamente dalla confezionatrice verticale. A richiesta puo' essere fornita con datario per l'incisione della data sul clip. Questa macchina è una novità assoluta, per la sua alta produttività, flessibilità, le sue ridotte dimensioni ed il basso consumo di aria.

Automatic binder with continuous plastic double-wired clipband for closing each type of bag. Compact, simple, safe, it has been designed with highly reliable technology. It is especially indicated for packaging of bakery products (bread, biscuits, breadsticks, etc.). On request, a date printer can be supplied, for printing the date on the clip. The bags are loaded directly of the vertical packaging machine. This machine is an absolute novelty and it is characterised by its high productivity, flexibility, lower dimensions and low air consumption.

Machine automatique à bande de clip continue plastifiée (clipband) a double à me en metal pour attacher n'importe quel type de sachet. Compacte, simple, sure, elle a été conçue au moyen de technologies hautement fiables. Est particulièrement indiquée pour le conditionnement de produits de boulangerie (pain, biscuits, gressins etc.). Peut fournie sur demande avec un dateur pour graver la date sur le clip. Les sachets sont directement chargée par la conditionneuse verticale. Cette machine est une nouveauté absolue et se caractérise par sa haute productivité, sa flexibilité, ses dimensions réduites et sa faible consommation d'air.

Automatische Maschine für Endlos-Kunststoffbindestreifen mit zwei außen liegenden Drahten (clip band) zur Verschiebung von Tüten aller Art. Kompakt, simple und sicher, wurde die Maschine mit zuverlässiger Technologie entwickelt. Besonders geeignet für die Verpackung von Backwaren (Brot, Kekse, Grissini etc.). Auf Wunsch mit Datumsstempel zur Einprägung des Datums auf dem Clip lieferbar. Die Verladung der Tüten erfolgt direkt durch die vertikale Verpackungsmaschine. Diese Maschine ist eine absolute Neuheit und durch ihre hohe Produktivität, geringen Ausmaße und niedrigen Luftverbrauch charakterisiert.

Maquina automática con clip band continua plastificada, de doble alma metilica, para el cierre de cualquier tipo de bolsa. Compacta, simple, segura, ha sido proyectada con tecnologías de gran confiabilidad. Esta' especialmente indicada para el empaquetado de productos de horno, (pan, galletas, grises etc.). A pedido puede entregada con un fechador para la escritura de la fecha sobre el clip. La carga de las bolsas la efectua directamente la empaquetadora vertical. Esta máquina es una novedad absoluta y se caracteriza por su elevada productividad y flexibilidad, sus dimensiones reducidas y el bajo consumo de aire.

CARATTERISTICHE TECNICHE

Comando	Elettro/pneumatico
Velocità meccanica	Max 40 conf./minuto
Potenza installata	Kw 0,1 24V/400V-AC
Consumo aria	2 litri/ciclo 7 bar
Bobina clipband	mm 0,6 mt 500 per 12.500 clip
Peso macchina	Kg. 22

TECHNICAL DATA

Control	Electro/pneumatic
Mechanic speed	Max 40 bags/min
Electrical connection	Kw 0,1 24V/400V-AC
Air consumption	2 ltr/cycle 7 bar
Clipband reel	mm 0,6 mt 500 for 12.500 clipping
Machine weight	Kg. 22

CARATTERISTICHE, MISURE E PESI SONO INDICATIVI E NON IMPEGNATIVI
SPECIFICATIONS, MEASURES AND WEIGHT ARE JUST FOR INFORMATION AND NOT BINDING